

ATTACK 4YWD

Frequency Hopping Spread Spectrum

2.4GHz
FHSS



4YWD
4-channel, FHSS
Radio control system
for EP Car

INSTRUCTION MANUAL

1M23N28702

Futaba® *Digital Proportional R/C System*



Thank you for purchasing a Futaba 4YWD FHSS 2.4GHz system.

This system is based on the combination of the newly developed 2.4GHz transmitter and its corresponding receiver. Before using your 4YWD 2.4GHz system, read this manual carefully and use your R/C set safely.

After reading this manual, store it in a safe place.

FHSS 4YWD 2.4GHz system

- 2.4GHzSS (Spread Spectrum) radio communication system
- Frequency channel setting unnecessary: Sifting the channels within the 2.4GHz band automatically, this system minimizes the interference from other 2.4GHz systems.
- Accepts no unwanted signals by using ID code
- Built-in antenna (T4YWD-2.4G transmitter)
- FHSS (Frequency Hopping Spread Spectrum) minimizes interference from other 2.4GHz systems. This system is not compatible with FASST.

Application, Export, and Modification

1. This product may be used for models only. It is not intended for use in any application other than the control of models for hobby and recreational purposes.

2. Exportation precautions:

(a) When this product is exported from the country of manufacture, its use is to be approved by the laws governing the country of destination which govern devices that emit radio frequencies. If this product is then re-exported to other countries, it may be subject to restrictions on such export. Prior approval of the appropriate government authorities may be required. If you have purchased this product from an exporter outside your country, and not the authorized Futaba distributor in your country, please contact the seller immediately to determine if such export regulations have been met.

(b) Use of this product with other than models may be restricted by Export and Trade Control Regulations, and an application for export approval must be submitted.

3. Modification, adjustment, and replacement of parts: Futaba is not responsible for unauthorized modification, adjustment, and replacement of parts on this product. Any such changes may void the warranty.

Compliance Information Statement (for U.S.A.)

This device, trade name Futaba Corporation, model number R214GF-E, complies with part 15 of the FCC Rules. Operation is subject to the following two conditions:

- (1) This device may not cause harmful interference, and
- (2) This device must accept any interference received, including interference that may cause undesired operation.

The responsible party of this device compliance is:

FUTABA Corporation of America

2681 Wall Triana Hwy Huntsville, AL 35824, U.S.A.

Phone:1-256-461-9399 FAX:1-256-461-1059

Battery Recycling (for U.S.A.)



The RBRC™ SEAL on the (easily removable) nickel-cadmium battery contained in Futaba products indicates that Futaba Corporation is voluntarily participating in an industry program to collect and recycle these batteries at the end of their useful lives, when taken out of service within the United States. The RBRC™ program provides a convenient alternative to placing used nickel-cadmium batteries into the trash or municipal waste system, which is illegal in some areas.

You may contact your local recycling center for information on where to return the spent battery. Please call 1-800-8-BATTERY for information on NiCd battery recycling in your area. Futaba Corporation's involvement in this program is part of its commitment to protecting our environment and conserving natural resources.

RBRC™ is a trademark of the Rechargeable Battery Recycling Corporation.

Safety Precautions	4
Definition of Symbols	4
2.4GHz System Precautions	4
Operation Precautions	5
Storage and Disposal Safety Precautions	6
Other Safety Precautions	7
Before Operation	8
System Contents	8
Nomenclature / Handling	9
Assembly / Adjustment	12
Receiver and Servo Connection	12
How to Link Transmitter and Receiver	13
Assembly Precautions	14
Transmitter Set-Up Procedures	15
4YWD Functions	16
Trim	16
Stick Adjustment	17
MC231CR Operation	17
MC231CR Function	18
Power Down Mode	19
Reference	20
Ratings	20
Troubleshooting	21
Error Displays	22
When Requesting Repair	22

Safety
Precautions

Before
Operation

Assembly /
Adjustment

4YWD-2.4G
Functions

Reference

Warning: This product contains a chemical known to cause cancer and birth defects (or other reproductive harm).

- No part of this manual may be reproduced in any form without prior permission.
- The contents of this manual are subject to change without prior notice.
- This manual has been carefully written. Please write to Futaba if you feel that any corrections or clarifications should be made.
- Futaba is not responsible for the use of this product.



Safety Precautions

For your safety as well as that of others, please read this manual thoroughly prior to installation and operation of your digital proportional R/C system.



Definition of Symbols

The following defines the symbols used in this manual.

Explanation of Symbols





 DANGER	Procedures which may lead to a dangerous condition and cause death or serious injury to the user if not carried out properly.
 WARNING	Procedures which may lead to a dangerous condition or cause death or serious injury to the user if not carried out properly, or procedures where the probability of superficial injury or physical damage is high.
 CAUTION	Procedures where the possibility of serious injury to the user is small, but there is a danger of injury, or physical damage, if not carried out properly.

Explanation of Graphic Symbols

-  Indicates an operation that prompts a warning (including Caution).
-  Indicates an operation that must not be performed.
-  Indicates an operation that always must be performed.

2.4GHz System Precautions

WARNING

-  Do not cover/hold the built-in antenna part of T4YWD-2.4G transmitter by your hand during running. Do not put any conductive plate/sticker on the antenna part. Otherwise, the operating range may become shorter.
-  Do not perform the linking procedure when motor's main wire is connected is operating as it may result in serious injury.
-  While the linking is done, please cycle receiver power and check if the receiver to be linked is really under the control of the transmitter to be linked.
-  Always use R214GF-E under 7.4V NiCd/NiMH battery or regulated output from your ESC. Using dry cell batteries may cause malfunction. Be sure that when using an ESC's regulated output, the capacity of the ESC meets your usage condition.
-  In order to maintain complete control of your car it is important that it remains visible at all times. Running behind large objects is not suggested. Doing so may result in the reduction of the quality of the radio frequency link to the model.

Operation Precautions

WARNING

 When using a NiCd/NiMH battery to power your system, always charge and check the battery voltage prior to operation. Should the battery discharge below the minimum voltage level, control will be lost.



 Prior to operation always perform a range test. Even one abnormality in the R/C system may cause loss of control.

[Range Test Procedure]

Have a friend hold the model, or place on a stand where the wheels or prop can not come in contact with any object. Operate from a distance of about 100 feet. Be sure to check the movement of each servo to make sure it follows the movement of the steering stick and throttle stick. If the servos do not follow the commands from the transmitter or any type of interference is detected, do not operate the model.

 Never operate in the rain or run through puddles. The transmitter, receiver, batteries and most servos, and speed controls are not waterproof. Contact with any type of moisture or immersion in water or snow will cause damage along with possible loss of control. Should any type of moisture enter any component of the system, immediately stop using the R/C system and return it to our service center for inspection.

 Do not operate when visibility is limited. Should you lose sight of the model, a collision or other dangerous situation may occur.

 Do not operate near people or roads.
 Do not operate near high tension power lines or communication broadcasting antennas.

Prior to the operation of any model be sure the area you plan to use is safe. Be aware of all objects that may be in the path of your model. Do not operate the model where people or any type of moveable object could stray in the path of your model. Control loss due to interference, component failure, loss of sight or low battery voltage could result in serious injury to yourself and others as well as damage to your model.

 Do not operate when you are tired, not feeling well or under the influence of alcohol or drugs.

Your judgment is impaired and could result in a dangerous situation that may cause serious injury to yourself and others.

 (Turning on the power switches)
Always check the throttle stick on the transmitter to be sure it is at the neutral position.

1. Turn on the transmitter power switch.
2. Turn on the receiver or speed control power switch.

(Turning off the power switches)

Always be sure the motor is stopped.

1. Turn off the receiver or speed control power switch.
2. Then turn off the transmitter power switch.

If the power switches are turned off in the opposite order the model may unexpectedly run out of control and cause a very dangerous situation.

 Make all adjustments to the radio control system with the electric motor disconnected.

If the motor is connected while adjustments are made, the model may run out of control.

 Remove the main battery source from electric powered models when they are not being used.

Should you accidentally leave the receiver switch on, the model could run out of control.

CAUTION

 Do not touch the motor, speed control or any part of the model that will generate heat while running.

Touching hot parts will result in serious burns.

 When the charger is not in use, disconnect it from the outlet. This will prevent accidents, overheating and short circuits.

Storage and Disposal Safety Precautions

WARNING

 At the end of a day's operation, store the system with NiCd/NiMH battery discharged. Be sure to recharge the system before it is used again.

You should fully discharge your system's batteries periodically to prevent a condition called "memory". For example, if you only make two runs in a day or you regularly use a small amount of battery's capacity, the memory effect can reduce the actual capacity even if the battery is charged for the recommended amount of time.

 Do not throw a NiCd/NiMH battery into a fire. Do not disassemble or attempt to repair a NiCd/NiMH battery pack.

Overheating, damage and acid leakage may lead to burns, loss of eye sight as well as numerous other types of injuries. The electrolyte in NiCd/NiMH batteries is a strong alkali. Should you get even the smallest amount of the electrolyte in your eyes, Do Not rub. Wash immediately with water, and seek medical attention at once. The electrolyte can cause blindness. If electrolyte comes in contact with your skin or clothes, wash with water immediately.

 Do not leave the radio system or models within the reach of small children. A small child may accidentally operate the system. This could cause a dangerous situation and injuries. NiCd/NiMH batteries can be very dangerous when mishandled and cause chemical damage.

CAUTION

 Do not store your R/C system where it will be exposed to the following conditions.

- Extreme heat or coldness
- Exposed to direct sunlight
- Where humidity is high
- Where vibration is prevalent
- Where dust is prevalent
- Where there is steam and condensation

Storing your R/C system under adverse conditions could cause deformation and numerous other problems with operation.

 If the system will not be used for a long period of time, remove the batteries from the model and store in a cool, dry place.

If the batteries are left in the model, electrolyte may leak and damage the model.

<NiCd/NiMH Battery Recycling>

A used NiCd/NiMH battery is valuable resource. Insulate the battery terminals and dispose of the battery by taking it to a battery recycling center.

Other Safety Precautions

CAUTION

 When operating two or more models at the same time, have a third person act as a spotter. They will be in charge of safety and you should follow their instructions.

 Beginners should receive instructions regarding safety and operation from an experienced modeler.

 Always use only genuine Futaba transmitter, receivers, servos, and electronic speed controls, along with other optional parts and components.

Futaba will not be held responsible for damages caused by other than genuine Futaba parts and components. Use only genuine Futaba parts and components listed in the instruction manual and catalog.

 Never use the T4YWD/R214GF-E in GP models (engine models), model boat and air models (airplane, helicopter, glider, etc.).

 T4YWD/R214GF-E can be used only for electric model cars.

 Do not short circuit the battery terminals.
Short circuiting the terminals will lead to sparks and overheating and could cause a fire and burns as well.

 Do not expose plastic parts to fuel, motor spray, waste oil or exhaust.
The fuel, motor spray, waste oil and exhaust will penetrate and damage the plastic.

<NiCd/NiMH Battery Electrolyte>

The electrolyte in NiCd/NiMH batteries is a strong alkali. Should you get even the smallest amount of the electrolyte in your eyes, DO NOT RUB. Wash immediately with water and seek medical attention at once. The electrolyte can cause blindness. If electrolyte comes in contact with your skin or clothes, wash with water immediately.



Before Operation

System Contents

After opening the container, check the contents for the following items. The contents will vary with the system purchased.

4YWD-2.4GHz System Contents			
Transmitter	T4YWD-2.4G (x1)		
Receiver	R214GF-E (x1)		
Servo	-----	S3003 (x3)	S3003 (x2)
E.S.C.	-----	-----	MC231CR (x1)
Switch	SSW-GS (x1)		-----
Miscellaneous	Mini Screwdriver Shift Gate Plate Manual *Servo mounting hardware and servo horns (only servo set)		

NOTE: Futaba FHSS system, T4YWD transmitter and R214GF-E receiver, does **not** work with current Futaba FASST systems. Please use T4YWD and R214GF-E in **pairs**. Futaba FASST system and FHSS system are **not compatible** each other.

Nomenclature / Handling

Transmitter **T4YWD**

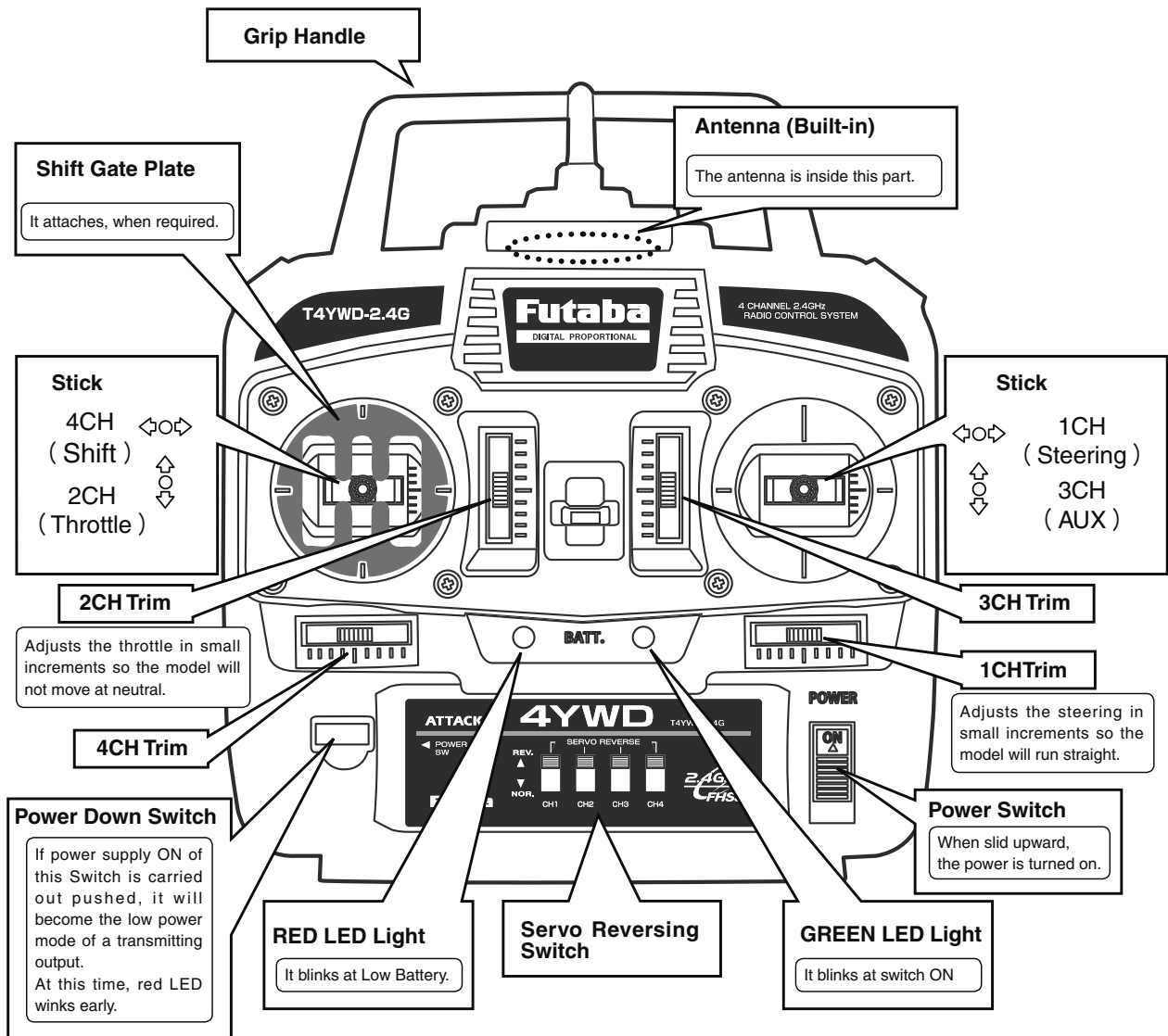

WARNING

-  Do not cover/hold the built-in antenna part of T4YWD transmitter by your hand during running.
Do not put any conductive plate/sticker on the antenna part.
Otherwise, the operating range may become shorter.

Battery Replacement Method

- 1** Remove the battery cover from the transmitter by sliding it in the direction of the arrow in the figure.
- 2** Remove the used batteries.
- 3** Load the new AA size batteries. Pay very close attention to the polarity markings and reinsert accordingly.
- 4** Slide the battery cover back onto the case.

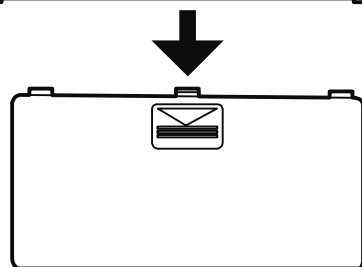
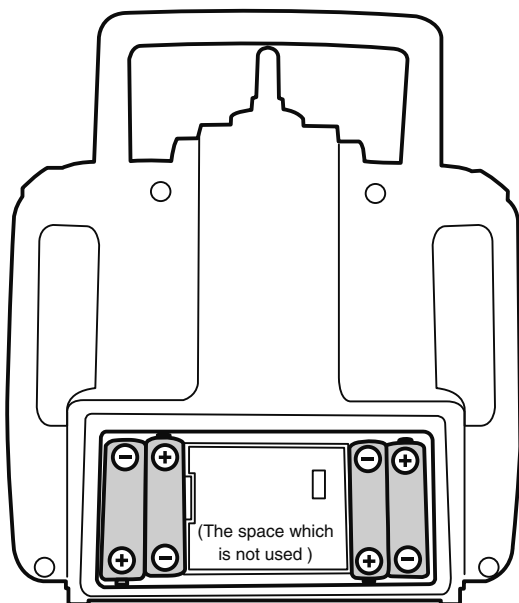

Battery Cover

(4 AA size batteries)

⚠ CAUTION

⚠ Always be sure you reinsert the batteries in the correct polarity order.

If the batteries are loaded incorrectly, the transmitter may be damaged.

⚠ When the transmitter will not be used for any short or long period of time, always remove the batteries.

If the batteries do happen to leak, clean the battery case and contacts thoroughly. Make sure the contacts are free of corrosion.

Low Battery :

When the LED starts blinking, change the batteries immediately.

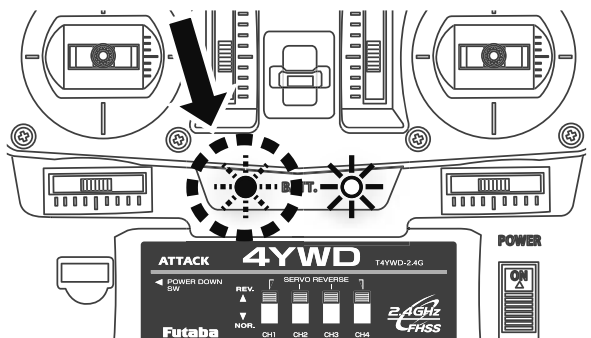

(If voltage is about **4.0v** or less, a **blink** indication of the **RED LED**.)

The low battery alarm is meant to be a safety feature only. Do NOT operate your radio below low battery. Always shut your radio off as soon as possible after the low battery warning loss of control.

Receiver R214GF-E

Servo S3003

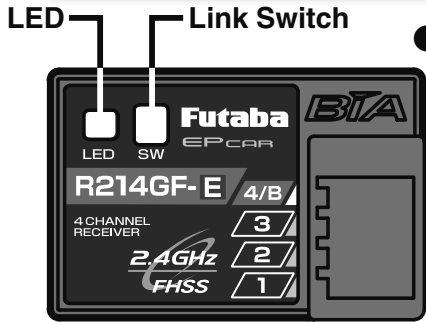

● **Built-in antenna**
 The **R214GF-E** receiver is designed to be used **only for EP Car models.**

- **Connectors**
- "4/B": CH4 Servo / Battery connector
- "3" : CH3 Servo
- "2" : Throttle Servo (CH2)
- "1" : Steering Servo (CH1)
- *A battery can connect any slot.

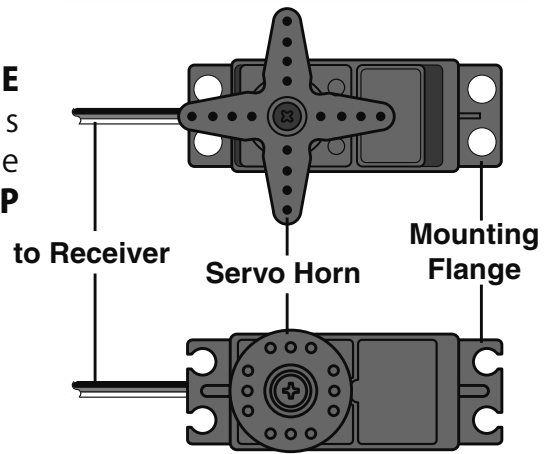

! WARNING

! Keep the receiver as far away from the motor, ESC and other noise sources as possible.

E.S.C. MC231CR

Applicable motors (Number of turns is criteria.)

•Use the MC231CR with a motor with 23T or more turns.
 *If a motor with a number of turns smaller than the above is used, the heat protector and overcurrent protection circuit may operate. The number of turns of the motor is only one criteria. Depending on the running conditions, the protection circuit may operate even if the condition above is satisfied.

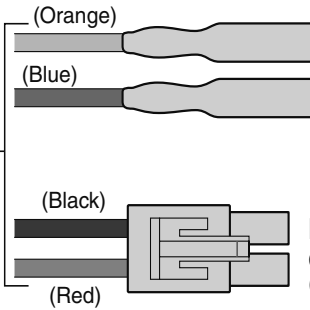
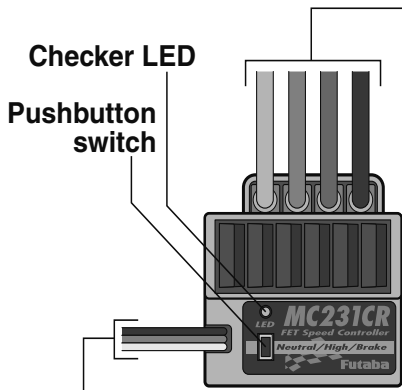

Motor connector
 Connects to the motor. (Orange) is positive. (Blue) is negative. If the motor rotates in the wrong direction, interchange the connections of this connector.

NiCd/NiMH battery connector
 Connects to the running NiCd/NiMH battery. (Red) is positive. (Black) is negative.

NiCd/NiMH battery 6~7 cells (7.2~8.4V)

Receiver connector
 Connects to the receiver throttle channel.

Miniature screwdriver
 Accessory. Use to press the pushbutton switch.



Receiver and Servo Connection

As you connect the receiver, servos and other components, do so in accordance with the "Assembly Precautions".

Connections when a E.S.C. MC231CR used.

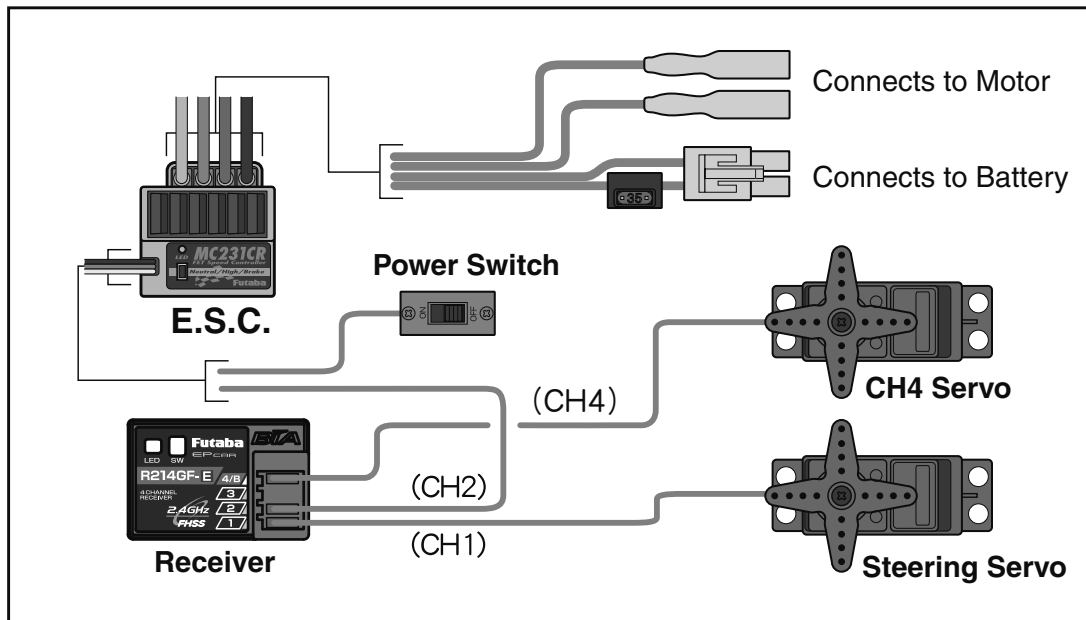

E.S.C not used Model

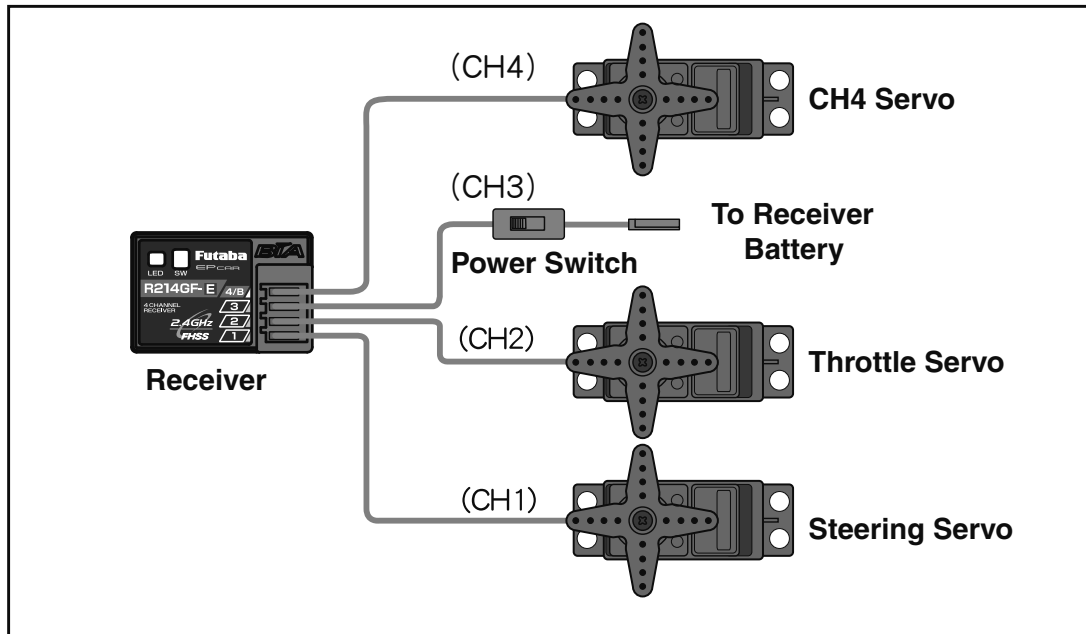

How to Link Transmitter and Receiver

Each transmitter has an individually assigned, unique ID code. In order to start operation, the receiver must be linked with the ID code of the transmitter with which it is being paired. Once the link is made, the ID code is stored in the receiver and no further linking is necessary unless the receiver needs to be used with an other transmitter. (For T/R set, the link is already done at factory.)

Link procedure

- 1 Bring the transmitter and the receiver close to each other, within 0.5 meter.

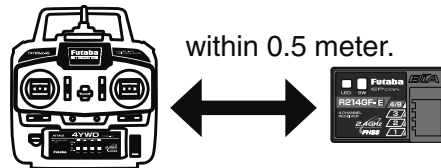

- 2 Turn on the transmitter and the receiver.

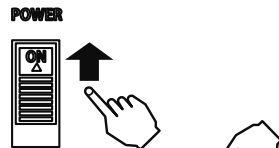

- 3 Push and hold the Link Switch of the receiver.

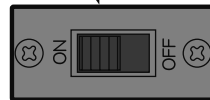

Push and hold the Link Switch

- 4 When the link is complete, the LED in the receiver changes to solid green.

*Please refer the table below for LED status vs receiver's condition.

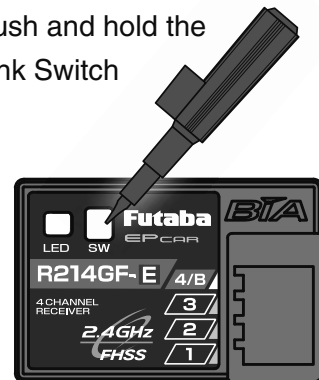

LED status vs receiver's condition:

Receiving no signals	OFF
Receiving signals	On
Receiving signals, but ID is unmatched.	Blink

⚠ WARNING

- ⚠ After the linking is done, please cycle receiver power and check that the receiver to be linked is really under the control of the transmitter.
- ⊘ Do not perform the linking procedure with motor's main wire connected as it may result in serious injury.

Assembly Precautions

WARNING

 Check the receiver, servos, and battery connectors, to be sure they are firmly connected.
If a connector is not fully inserted, vibration may cause the connector to work loose while the model is operating. This will result in loss of control.

 Operate each servo horn over its full stroke and check to see that the linkage does not bind or is not too loose.
Excessive force applied to the servo horn by binding or poor installation may lead to servo problems and result in loss of control.





 Isolate the receiver from vibration by attaching to the chassis or mounting plate with thick double sided tape.

 Any contact with moisture (water or condensation) may cause receiver malfunction and loss of control.

 Use the servo horn screw.
When the servo horn comes off, it becomes loss of control.

 Keep all devices that emit high frequency noise, such as motors, batteries, and wiring that handles heavy current loads, at least 1/2 inch away from the receiver.
High frequency noise will cause a decrease in operating range and could cause loss of control.

 Install electronic speed controller heat sinks as well as other components that conduct electricity must not contact with aluminum, carbonfiber or other materials that conduct electricity.
If, for example, the electronic speed controller come loose while the model runs, and touches aluminum chassis, a short circuit may occur and it cause irreparable damage to the system as well as loss of control.

 Noise suppression capacitors should be installed on almost all motors.
If the proper capacitors are not installed, high frequency noise will reduce range and cause loss of control along with various other problems.

 Inspect all linkage installations and any point where metal could come in contact with other metal parts. Make sure these parts do not touch other metal parts under vibration.
Should a linkage or other metal parts come in contact with other metal parts under vibration, the high frequency noise generated by this contact will cause interference and possible loss of control.

CAUTION

 Do not disassemble any part of this system that is not specified in the instruction manual.
Futaba will not be responsible for any damage due to improper disassembly of any part of the radio control system.

Transmitter Set-Up Procedures

*When making these settings adjustments, with the motor connector disconnected.

Servo Horn Installation Instructions

1 Connect the receiver, servos, and other components and then turn on the power switches to transmitter and receiver.

*Both servos will move to the neutral position.

2 At this time install the servo horn in the manner described in the instruction manual provided with the model this system will be used in.

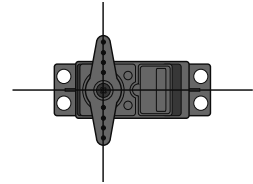

Reversing The Servo Operation Direction

Should the servo operate in the opposite direction required for your application, reverse the direction with the servo reversing.

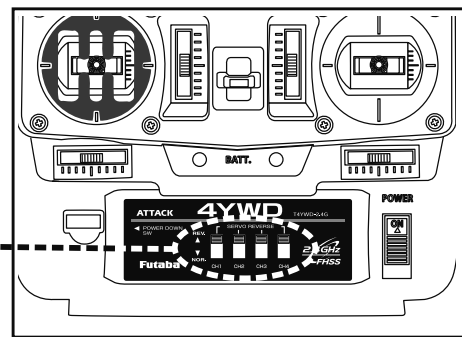
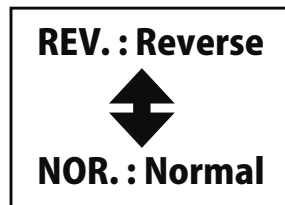

E.S.C. MC231CR

NEUTRAL, HIGH, AND BRAKE MAX POINT SETTINGS

Before setting each point, set the transmitter throttle channel trim to neutral.

1 Turn on the power in transmitter → amp order.

	Transmitter throttle operation	MC231CR (Pushbutton switch operation) (Checker LED)	
2 Neutral point setting	<ul style="list-style-type: none"> •Neutral state 	<ul style="list-style-type: none"> •Press the pushbutton switch (0.5 secs or longer) (Confirmation beep sounds) 	<ul style="list-style-type: none"> •Continuous single blink
3 High point setting	<ul style="list-style-type: none"> •Full high state 	<ul style="list-style-type: none"> •Press the pushbutton switch (Confirmation beep sounds) 	<ul style="list-style-type: none"> •Continuous double blink
4 Brake MAX point setting	<ul style="list-style-type: none"> •Full brake state 	<ul style="list-style-type: none"> •Press the pushbutton switch (Confirmation beep sounds.) 	<ul style="list-style-type: none"> •If the LED goes out, setting is complete.

If the LED does not go off but blinks rapidly, setting was not performed normally. Repeat setting from "Neutral point setting".

•Continuous rapid blink

* Since the data is read at the end of setting of all points, the points cannot be set independently.
 * If the amp power was turned off during setting, the setting points cannot be memorized. (The previous settings are retained.)
 * The confirmation beep sounds only when the motor was connected.

Trim

Neutral adjustments can be made by moving the trim to the left or right (Up or down).

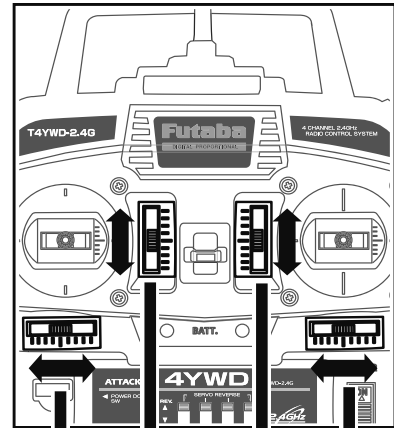

- CH1 Trim : Steering (1CH)
- CH2 Trim : Throttle (2CH)
- CH3 Trim : AUX (3CH)
- CH4 Trim : AUX (4CH)

Servo install

When you install a servo, always check to be sure the servo is at its neutral position. Adjust the servo horn hole position and linkage so both are parallel. When a servo saver is used, place it as close to center position as possible. Be sure the steering trim on the transmitter is at the neutral position.

Trim Operation And Maximum Position

Changing the trim can affect the overall settings. When adjustments are made with the trims, recheck your installation for maximum position.

When Trim usage is extreme

If it takes most of your trim movement to get a servo to the neutral position, reposition the servo horn or servo saver on the servo and inspect your linkage installation.

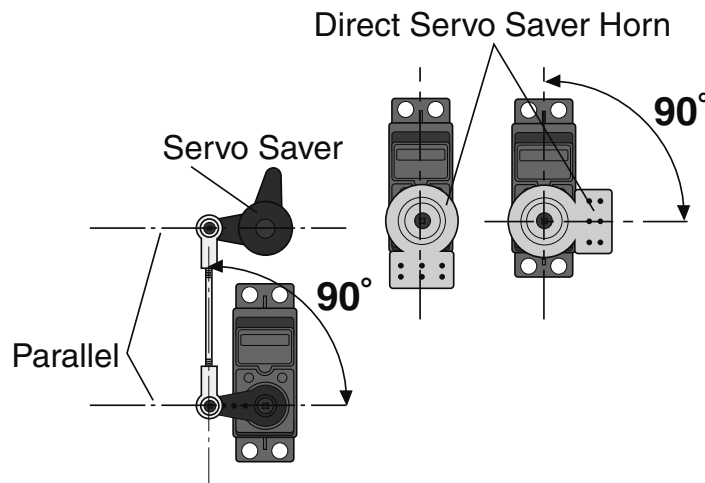

Stick Adjustment

Adjustment of the stick lever length.

You can adjust the length of stick levers, as you like. It is recommended to adjust the length of the sticks in line with your hand size.

1 Hold the lever head "B" and turn the lever head "A" counter-clockwise. The lock will be released.

2 Turn the lever-head "A" clockwise as you hold the lever-head "B" after placing it as you like.

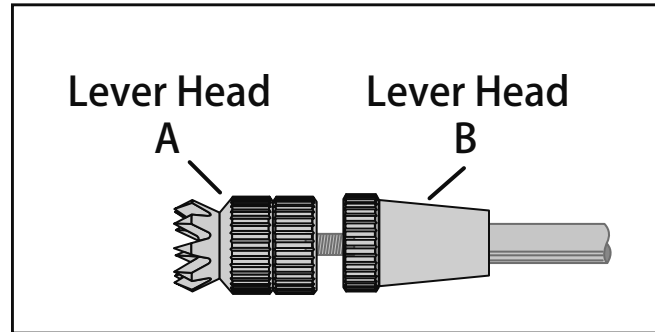

MC231CR Operation

Forward :

Throttle stick is turned up, the speed increases.

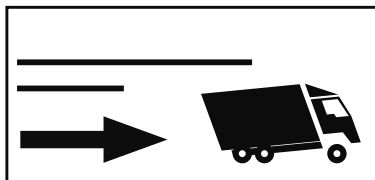
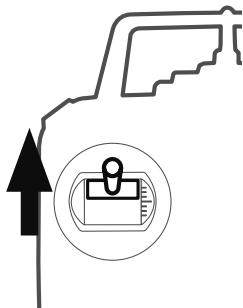

Brake :

Throttle stick is turned down, the brake works.

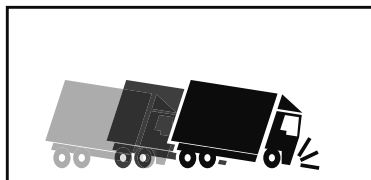
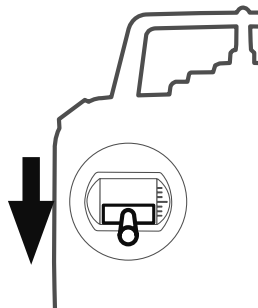

Reverse :

Operation can be switched to reverse operation by returning the throttle stick from the brake position to the neutral position. Then turn down the stick.

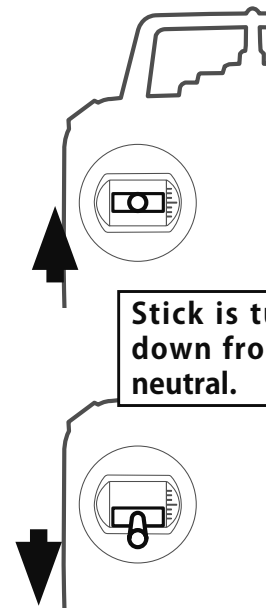

Stick is turned down from the neutral.

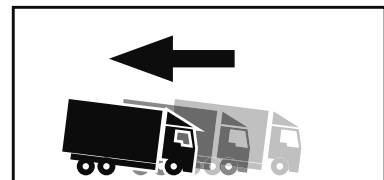

MC231CR Function

CANCELLING THE REVERSE FUNCTION

The amp reverse function can be cancelled by the following method so that the model can be used even in races that prohibit reverse running. (Brake operation only)

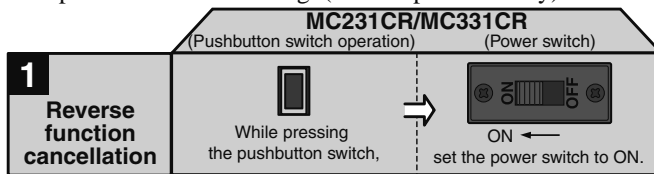

* When desired, you can enable the cancelled reverse function by repeating the operation shown at the left. (The reverse function is switched alternately.)

BRAKE/REVERSE OPERATING INSTRUCTIONS

Operation can be switched to reverse operation by returning the throttle stick from the brake position to the neutral position.





PROTECTION CIRCUIT OPERATION

The following protection circuits are built into the MC231CR. When a protection circuit operates, remove the cause before operating the model again.

Overcurrent protection	When an overcurrent flows due to an output short circuit, etc., the overcurrent protection circuit automatically limits the current to protect the FET. ⇒ Remove the cause of the short circuit, etc. before operating the model again.
Heat protector	When abnormal heating of the FET due to an overload, etc. is detected, the heat protector operates so that the speed is gradually reduced. ⇒ When the FET temperature drops, the heat protector automatically resets. However, remove the cause of the overheating before operating the model again.
Low voltage operation	When the NiCd/NiMH battery voltage drops, this function limits the motor output current and ensures steering operation. ⇒ After the speed drops, immediately recover the vehicle.

CHECKER LED DISPLAY

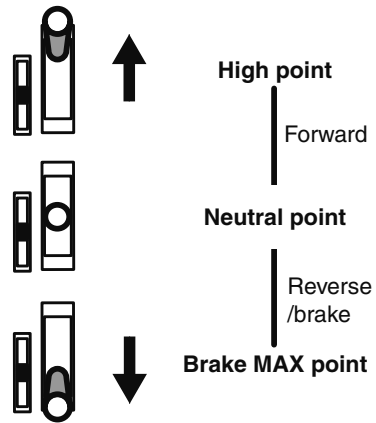
The amp operates linearly in proportion to the amount of forward, reverse, and brake operation. The amp operating state can be checked with the checker LED as shown below.

Operation	Checker LED display
Amp power ON	(Reverse operation set) Single blink (Single confirmation beep)  (Only brake operation set) Double blink (Two confirmation beeps) 
	Off On *Becomes brighter nearer the high point. Off On *Becomes brighter nearer the brake MAX point. Off
(Amp power left on alarm) When the transmitter power was turned off first.	Blinks. (Confirmation beep also sounds.)  *Not used with PCM receivers. *When the transmitter is OFF, this function is not performed in environments such that the servo operates erroneously.

* Confirmation beep only sounds when the motor was connected.

Power Down Mode

Range Testing Your R/C System

It is extremely important to range check your models prior to each running session. This enables you to ensure that everything is functioning as it should and to obtain maximum enjoyment from your time running. The T4YWD transmitter incorporates a system that reduces its power output and allows you to perform such a range check.

Power down mode Instructions

- 1** Push and hold the power down switch of the transmitter.
- 2** Turn on the transmitter.
- 3** It is shown that red LED blinks quickly and has become power down mode. In order to cancel a power down, a power down switch is released. Even if it continues pushing a power down switch, it is canceled in 90 seconds.

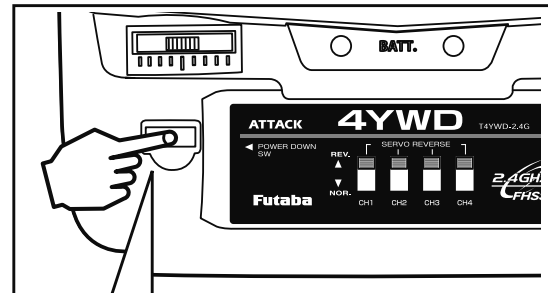
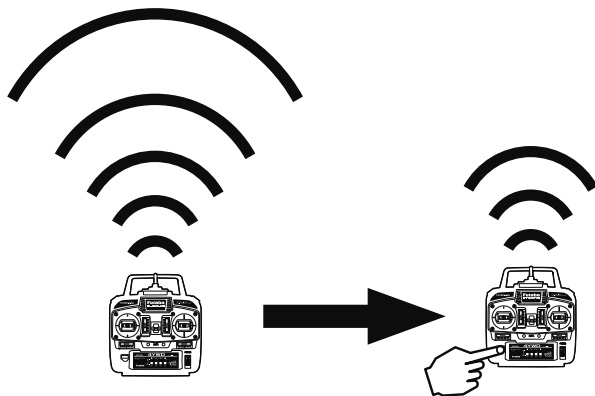

Push and hold the power down switch

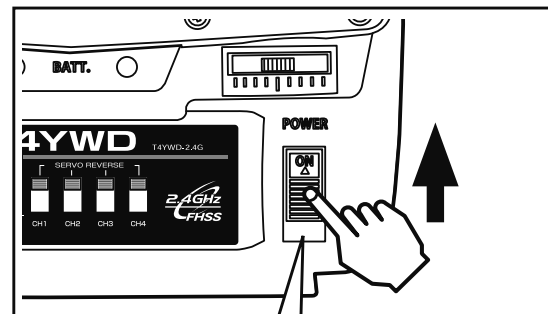

Turn on

A release of a power down switch will cancel power down mode.

With the "Power down mode" on, walk away from the model while simultaneously operating the controls. Have an assistant stand by the model to confirm that all controls are completely and correctly operational. You should be able to walk approximately 30-50 paces from the model without losing control. In the case of abnormalities, it does not run. It must be checked and fixed.

WARNING

-  Do not operate in the range check mode.
*Since the range of the radio waves is short, if the model is too far from the transmitter, control will be lost and the model will crash.

Ratings

*Specifications and ratings are subject to change without prior notice.

Communication method:

One-way operation system

Maximum operating range:

80m (Optimum condition)

Transmitter T4YWD

(FHSS system, 2 Stick type, 4 channels)

Transmitting frequency:

2.4GHz band

Power requirement:

(Dry cell battery) Penlight x 4(6V)

Current drain:

100mA or less

Transmission antenna:

1/2λ di-pole (Built-in)

Receiver R214GF-E

(FHSS/S-FHSS system, 4 channels, Used only for EP Car models.)

Power requirement:

4.8V ~ 7.4V Rechargeable battery

Size:

35.1x23.2x9mm (excluding a projection part)

Weight:

6g (0.21oz.)

Servo S3003

(Standard servo)

Power requirement:

6V (common with receiver)

Current drain:

8mA (at 6V / Idle)

Output torque:

4.1kgf-cm (57in.-oz.) at 6V

Operating speed:

0.19sec/60 degree at 6V

Size:

40.4x19.8x36mm (1.59x0.78x1.42in.)

Weight:

37.2g (1.31oz.)

E.S.C. MC231CR

(Electronic speed control)

Operating system:

Forward, reverse, and brake operations are all linear.

Power requirement:

NiCd/NiMH battery 6-7 cells (7.2 to 8.4V)

PWM frequency:

1.5kHz (fixed)

Setting:

One-touch input by pushbutton switch. Set data is saved to built-in EEPROM.

Current capacity (FET rating):

Forward=90A, reverse=45A

Size:

27.1x33.3x12.8mm (1.07x1.31x0.50in.)
 (excluding protruding parts)

Silicon cord gauge size:

AWG16 equivalent

Weight:

48g (1.69oz.)
 (including connectors and switches)

BEC voltage:

6.0V

NOTE: Futaba FHSS system, T4YWD transmitter and R214GF-E receiver, does not work with current Futaba FASST system. Please use T4YWD and R214GF-E in pairs. Futaba FASST system and FHSS system are not compatible each other.

Troubleshooting

If your system fails to operate or you experience a short range problem or erratic control, check the table below for possible causes. If after you have followed the suggestions listed the problem is not corrected, return the system to our service department for inspection and repair.

(Item Check)

Transmitter

Battery

- Dead battery → Change the batteries.
- Batteries inserted incorrectly. → Reload the batteries in accordance with the polarity markings
- Faulty contact → Check to see if the contacts are bent and not making good contact
- Dirty contacts → Clean the contacts and check for corrosion.

Receiver

Battery

- Low battery → Recharge

Monitor LED

- Check the LED of the receiver.
- Refer to the "How to link the transmitter and the receiver".

Connector connections

- Wiring incorrect → Insert all connectors firmly
- Loose connections → Push the connector in firmly

Linkage

- Binding or loose → Adjust the linkage in model
- Is movement stiff → Adjust linkage in model

Motor

- Noise problems → Install capacitors on motor

Error Displays

Low Battery

When the LED starts blinking, replace the batteries immediately.

LED light:

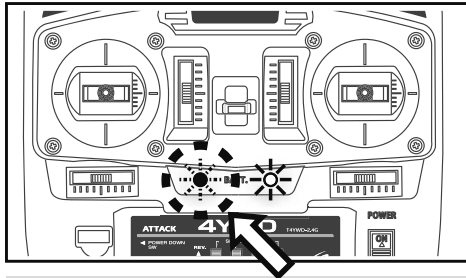

WARNING

 When a low battery alarm is generated, cease operation immediately and retrieve the model. If the battery goes dead while in operation, you will lose control.

When Requesting Repair

Before requesting repair, read this instruction again and recheck your system. Should the problems continue, request as follows.

(Information needed for repair)

Describe the problem in as much detail as possible and send the letter along with the system in question.

- Symptom (Including the conditions and when the problem occurred)
- R/C System (Send transmitter, receiver and servos)
- Model (Type of model, brand name and model number or kit name)
- Detailed packing list (Make a list of all items sent in for repair)
- Your name, address and telephone number.

(Warranty)

Read the Warranty card.

- When requesting warranty service, send the card or some type of dated proof of purchase.

Hobby Services (U.S. only)

FUTABA Corporation of America

2681 Wall Triana Hwy Huntsville, AL 35824, U.S.A.

Phone:1-256-461-9399 FAX:1-256-461-1059

service@futabaUSA.com

FEDERAL COMMUNICATIONS COMMISSION INTERFERENCE STATEMENT (for U.S.A.)

This equipment has been tested and found to comply with the limits for a Class B digital device, pursuant to Part 15 of the FCC Rules. These limits are designed to provide reasonable protection against harmful interference in a residential installation.

This equipment generates, uses and can radiate radio frequency energy and, if not installed and used in accordance with the instructions, may cause harmful interference to radio communications. However, there is no guarantee that interference will not occur in a particular installation. If this equipment does cause harmful interference to radio or television reception, which can be determined by turning the equipment off and on, the user is encouraged to try to correct the interference by one or more of the following measures:

- Reorient or relocate the receiving antenna.
- Increase the separation between the equipment and receiver.
- Connect the equipment into an outlet on a circuit different from that to which the receiver is connected.
- Consult the dealer or an experienced radio/TV technician for help.

CAUTION:

To assure continued FCC compliance: Any changes or modifications not expressly approved by the grantee of this device could void the user's authority to operate the equipment.

Exposure to Radio Frequency Radiation

To comply with FCC RF exposure compliance requirements, a separation distance of at least 20 cm must be maintained between the antenna of this device and all persons. This device must not be located or operating in conjunction with any other antenna or transmitter.

FUTABA CORPORATION

oak kandakajicho 8F 3-4 Kandakajicho, Chiyoda-ku, Tokyo 101-0045, Japan

TEL: +81-3-4316-4820, FAX: +81-3-4316-4823

©FUTABA CORPORATION 2018, 5 (2)